

Article number: 20163B30702SW

Description: E+G

Base plate clamp GN163-B30-70-2-SW

Measures

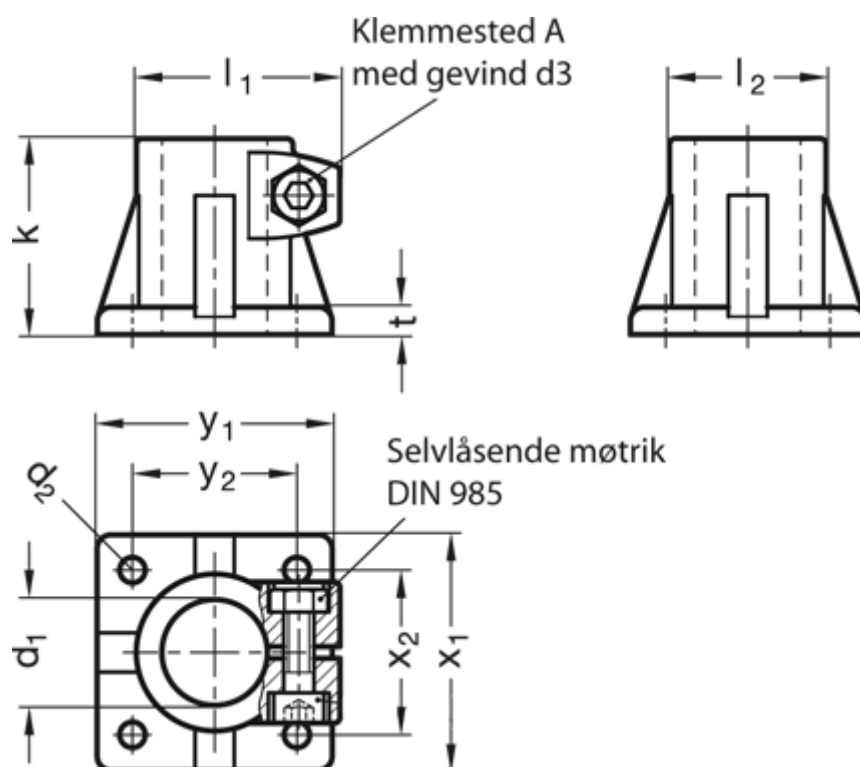

Adjustable clamp lever = GN 911-M10-40 have to be ordered separately

d1	= B30
d2	= 8.5
d3	= M10
k	= 70
l1	= 68.0
l2	= 56
t	= 10

x1 = 90
x2 = 64
y1 = 90
y2 = 64